

74

NAD SERVICE MANUAL

7140
AM/FM STEREO RECEIVER

NAD 7140 SERVICE MANUAL

NOTE: This manual covers all versions.

- A: U.S.A.
- A1: Canada
- B: U.K.
- B1: Australia
- C: EUROPE and others
- C1: W-Germany

TABLE OF CONTENTS	PAGE
LOCATION MAP	2
SPECIFICATION	3-5
INTERNAL VIEW	6
SUGGESTED INSTRUMENTATION HOOKUP	7
FM ALIGNMENTS	8-11
AM ALIGNMENTS	12-13
AMPLIFIER ALIGNMENTS	14
AMPLIFIER P.C.B. LAYOUT DIAGRAM	16-17
SCHEMATIC DIAGRAM (AMPLIFIER SECTION)	18-19
TUNER P.C.B. LAYOUT DIAGRAM	20-21
SCHEMATIC DIAGRAM (TUNER SECTION)	22-23
WIRING DIAGRAM	24-25
EXPLODED VIEW PARTS LIST	26-28
EXPLODED VIEW	29
ELECTRICAL PARTS LIST	30-34

7140
AM/FM STEREO RECEIVER

1. AM Rod Antenna
2. Antenna Terminals
3. Coaxial Antenna Input
4. Phono Input
5. MM/DC Phono Selector
7. CD Input
8. Aux Input
9. Tape Rec/Play
10. Preamp Out, Main In
11. Soft Clipping
12. Speaker Impedance
13. Bridging
14. AC Line Cord
15. AC Convenience Outlets (Not in European models)
16. Speakers A
17. Speakers B

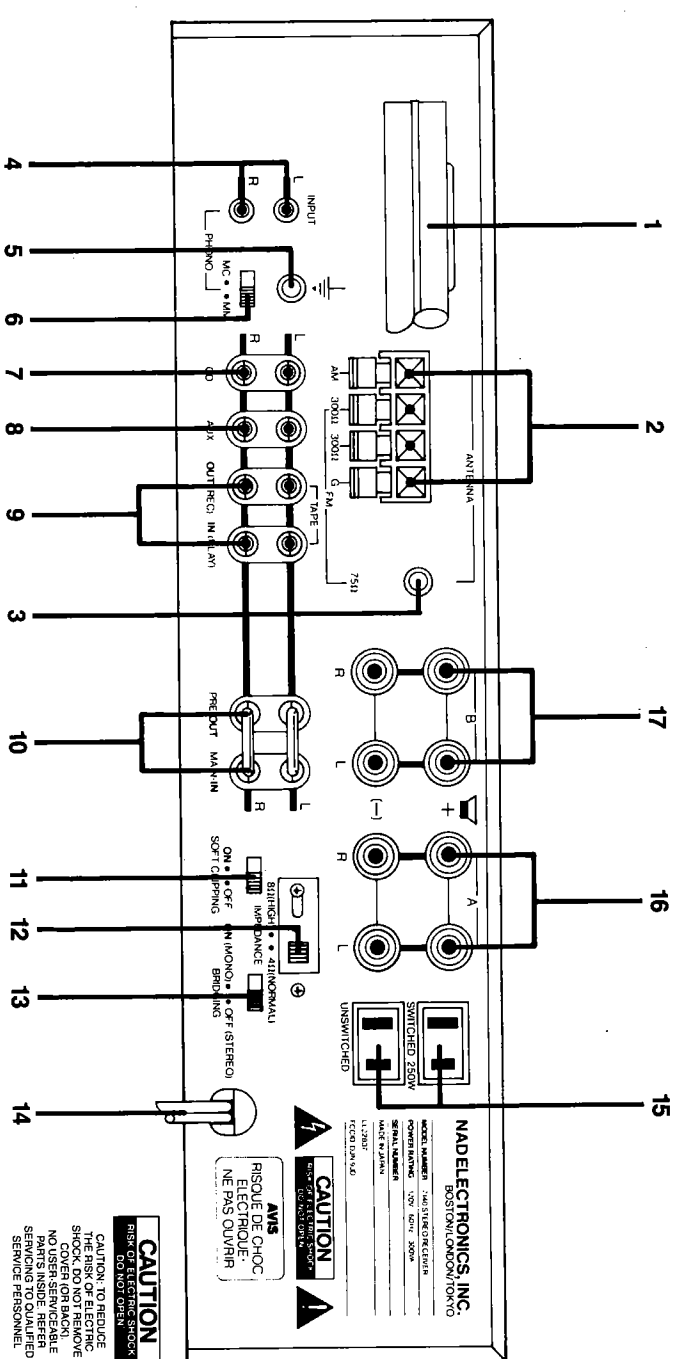

9. Dyn Sep Defeat
10. Tape Monitor
11. Input Selector
12. Low Level
13. Loudness Compensation
14. Volume/Balance
15. Tuning Search
16. Up/Down Tuning
17. AM/FM
18. Memory Enter
19. Station Pre-Set
20. FM Stereo Indicator
21. Soft Clipping Indicator
22. Tuning Display

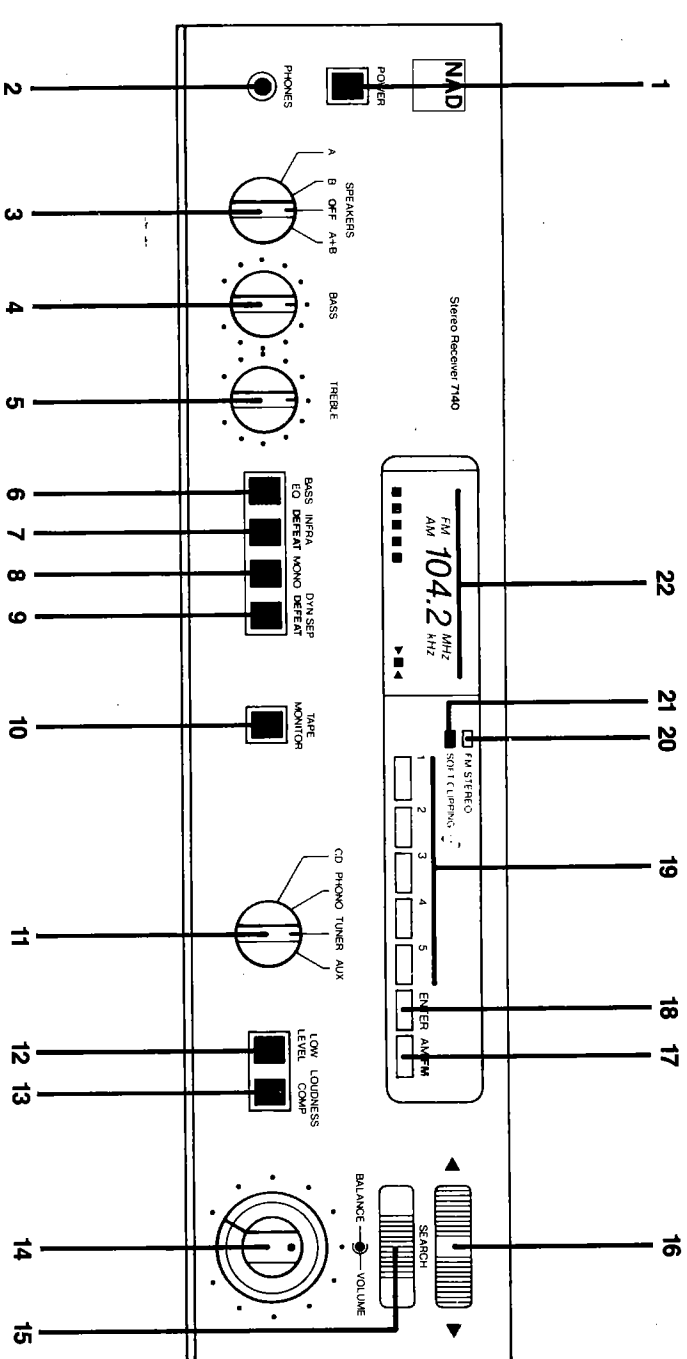

SPECIFICATIONS

NOTE: Measurements referenced to 8 ohms are taken with the Speaker Impedance Selector set to "8 ohm (High)". Measurements for 4 and 2 ohms are taken with the impedance selector at "4-ohm (Normal)". Specifications are measured in accordance with EIA Standard RS-490 (IHF A-202) for amplifiers and ANSI-IEEE Standard 185 (1975) (IHF T-200) for tuners. Tuner sensitivity is measured via 75 ohm coaxial input and converted to equivalent 300 ohm values.

POWER AMPLIFIER SECTION, STEREO MODE

USA version only

40 W (16 dBW)

All version except USA

40 W (16 dBW)

CONTINUOUS AVERAGE POWER OUTPUT INTO 8 OHMS

(min. RMS power per channel into 8 ohms, 20 Hz – 20 KHz, both channels driven, with no more than the rated distortion)

Rated distortion (THD), 20 Hz – 20 KHz

0.03 %

0.03 %

Clipping power (max. continuous power per channel)

8 ohms
55 W
4 ohms
65 W

8 ohms
55 W
60 W

IHF dynamic headroom at 8 ohms

+3 dB

+3 dB

IHF dynamic power (max. short-term power per channel)

8 ohms
80 W
4 ohms
95 W
2 ohms
110 W

80 W
90 W
100 W

Slew factor

> 50

Slew rate

20 V/ μ sec

Damping factor (ref. 8 Ω , at 50 Hz)

> 50

Input impedance

20 K Ω

Input sensitivity for 1 W/40 W out

170 mV/1000 mV

THD (Total Harmonic Distortion, 20 Hz – 20 KHz, from 250 mW to rated output)

< 0.03 %

SMPTE I.M. (Intermodulation Distortion, 60 Hz + 7 KHz, 4:1, from 250 mW to rated output)

< 0.03 %

IHF I.M. (CCIF IM Distortion, 19 + 20 KHz at rated output)

< 0.03 %

BRIDGED (MONOPHONIC) MODE

CONTINUOUS AVERAGE POWER OUTPUT INTO 8 OHMS

(min. RMS power into 8 ohms, 20 Hz – 20 KHz, with no more than the rated distortion)

100 W (20 dBW)

IHF Dynamic Headroom at 8 ohms

+2.5 dB

Dynamic power (max. short-term output, 8 ohms)

180 W

PREAMPLIFIER SECTION

PHONO INPUT

Input impedance (MM or MC)	R = 47 k Ω ; C = 100 pF
Input sensitivity (1 kHz)	MM: 0.4 mV for 1W out 2.5 mV for 40 W out MC: 0.04 mV for 1 W out 0.25 mV for 40 W out
Input overload at 20 Hz/1 kHz/20 kHz	MM: 18 mV/170 mV/1.5 V MC: 1.8 mV/17 mV/150 mV
THD (20 Hz - 20 kHz) and IM Dist. at +30 dB level	0.04 %
RIAA response accuracy	± 0.5 dB
S/N ratio, IHF A-weighted, with cartridge connected	MM: 78 dB re 5 mV MC: 76 dB re 0.5 mV

LINE LEVEL INPUT (AUX, TAPE)

Input impedance	R = 10 k Ω ; C = 220 pF
Input sensitivity	25 mV for 1 W out 150 mV for 50 W out
Maximum input signal	> 10 V
Signal to noise ratio, A-weighted	86 dB re 1W 102 dB re 40 W
Frequency response, 20 Hz - 20 kHz	± 0.5 dB

OUTPUTS

Preamp out impedance	800 ohms
Maximum output level	10 V
Tape output impedance	1,000 ohms (buffered)
Tape output infrasonic filter	-3 dB at 15 Hz, 12 dB/octave

CONTROLS

Treble	± 7 dB at 10 kHz
Bass	± 7 dB at 100 Hz
Speaker Equalization	+3 dB at 70 Hz, +6 dB at 32 Hz
Infrasonic filter (switchable)	-3 dB at 15 Hz, 12 dB/octave
Audio muting (low level)	-20 dB

FM TUNER SECTION

Input sensitivity	Mono, -30 dB THD + N Mono, 50 dB S/N Stereo, 50 dB S/N Stereo, 60 dB S/N	USA versions only 75 μ sec. deemphasis	All versions except USA 50 μ sec.
Capture ratio at 25, 45 and 65 dBf			
AM rejection			
Selectivity	Alternate channel Adjacent channel		
Image rejection			
R.F. intermodulation			
I.F. rejection			
SCA rejection			
Subcarrier suppression (19 & 38 kHz)			
THD at 100 % modulation	Mono Stereo	9.8 dBf (1.7 μ V/300 Ω) 13.2 dBf (2.5 μ V) 32 dBf (22 μ V) 42 dBf (70 μ V)	10.3 dBf (1.8 μ V/300 Ω) 15.8 dBf (3.2 μ V) 33.2 dBf (25 μ V) 43.1 dBf (78 μ V)
Signal-to-noise ratio A-weighted, 65 dBf	Mono Stereo		
Frequency response, 30 - 15 kHz			
Stereo separation (Dyn Sep off)	1 kHz 30 Hz - 10 kHz		

AM TUNER SECTION

Usable sensitivity	300 μ V/meter
Selectivity	35 dB
Image rejection	50 dB
I.F. rejection	50 dB

PHYSICAL SPECIFICATIONS

Dimensions (width x height x depth)	42 x 10 x 35 cm. 16.5 x 4 x 13.8 in.
Net weight	9.2 kg./20.3 lb.
Shipping weight	11.5 kg./25.4 lb.
Power requirements	50/60 Hz at 110, 120, 220, or 240 VAC 290 VA

INTERNAL VIEW

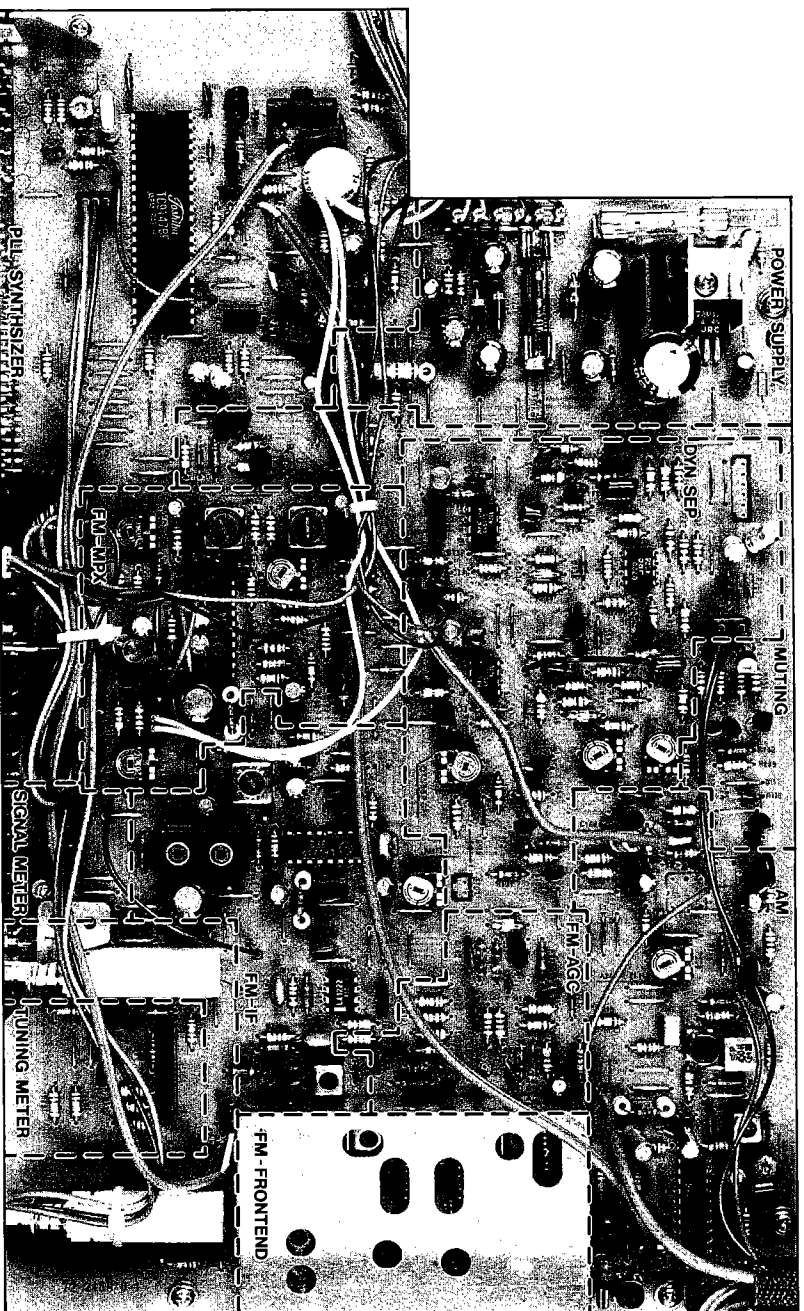

SUGGESTED INSTRUMENTATION HOOKUP

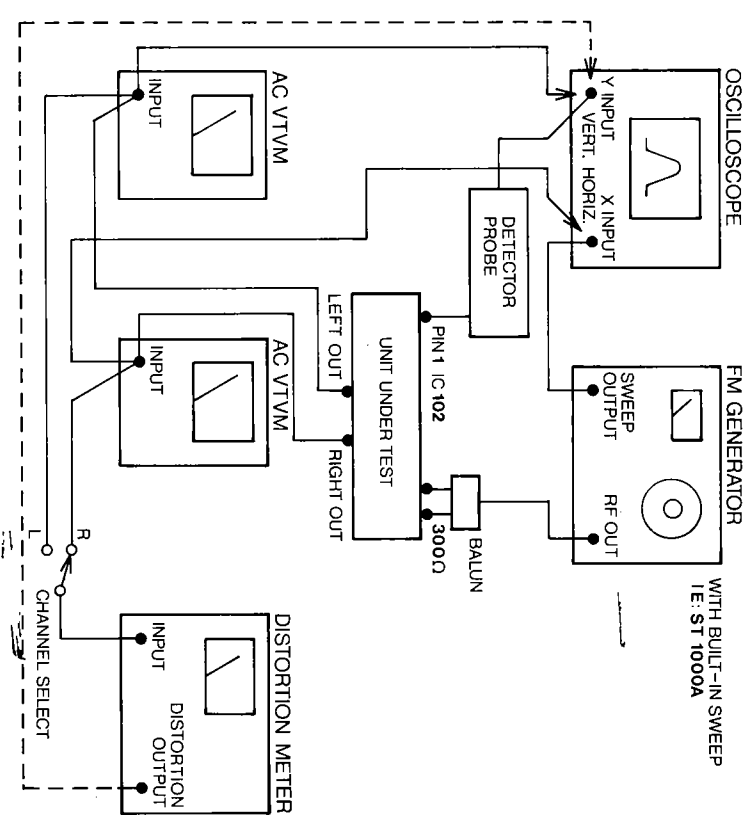
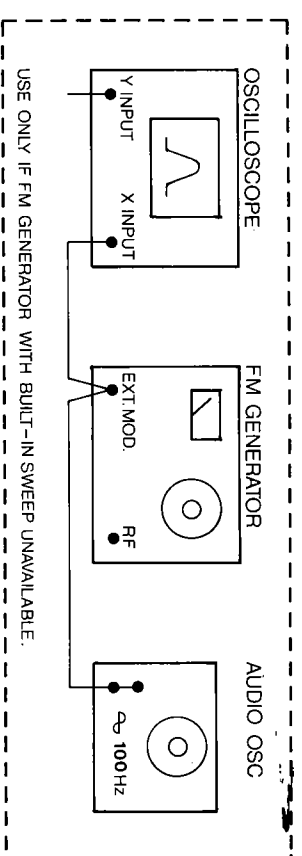

SCHEMATIC DIAGRAM OF DETECTOR PROBE

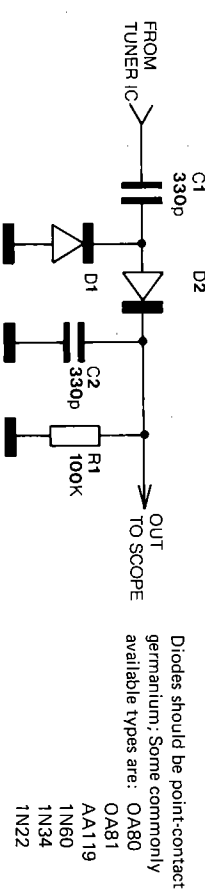

PICTORIAL DIAGRAM OF DETECTOR PROBE

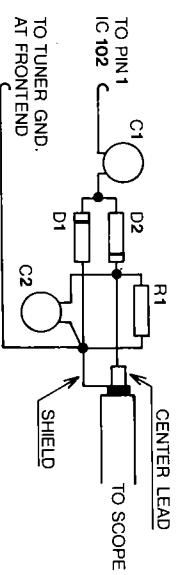

Keep leads as short as possible, to minimize stray signal pickup.

FM ALIGNMENTS

NECESSARY INSTRUMENTATION

FM GENERATOR (less than 0.05% THD)

STEREO GENERATOR (less than 0.05% THD, more than 50 dB sep.)

AUDIO GENERATOR (not necessary if FM generator has built in sweep; i.e., SOUND TECHNOLOGY ST 1000A and ST 1020A)

AC VTVM's (or one with a left/right switch)

THD ANALYZER (resolution less than 0.1%)

OSCILLOSCOPE (5mV or better sensitivity, X input capability)

FREQUENCY COUNTER

VOM or DMM (high impedance, must read in mV)

DETECTOR PROBE

IMPORTANT

While all FM generator output levels hereafter are referred to the 300 ohm input, 75 ohm input can be used, but be aware of possible equipment groundloops and divide the RF output levels by 2.

Before alignments commence, set input selector to tuner and release mono and dyn sep defeat switches (out).

FRONTEND

Alignment of frontend should only be necessary after repair to frontend or crystal oscillator circuits (pin 2 and 3 on IC 110).

A TUNING VOLTAGE (OSCILLATOR)

It is essential to check tuning voltage before aligning the rest of the frontend.

- 1 Connect DMM between ground and TP 102.
- 2 Tune to 108 MHz and adjust C 20 if voltage is incorrect.
SPECIFICATION $22V \pm 0.5V$
- 3 Tune to 88 MHz and read voltage. Adjust L 6 if voltage is incorrect.
SPECIFICATION $3.2V \pm 0.5V$
- 4 Repeat step 2 and 3 until readings are within tolerances.

B RF ADJUSTMENT (TRACKING)

- 1 Connect RF generator to 300 ohm antenna input and detectorprobe to pin 1 IC 102 with ground to tunershield. Adjust sensitivity of oscilloscope to maximum (5mV or better) and modulate FM generator sweep ± 300 kHz or more.
- 2 Set tuner to 105 MHz, enter into preset 5, and tune generator so that curve appears on oscilloscope. Turn down RF input level so that curve covers approximately 1/2 of oscilloscope display.
- 3 Adjust C 2, C 10 and C 12 to maximum curve height while reducing input to keep entire curve on display.
- 4 Set tuner to 90 MHz, enter into preset 1, and tune generator so that curve appears on oscilloscope display.
- 5 Adjust L 2, L 4 and L 5 to maximum curve height. The coils adjust by gently extending or contracting the aircoil with a non-metallic or non-static tool (i.e., plastic knit-pin or a wooden stick). Be careful not to deform the coils.
- 6 Repeat steps 2, 3, 4 and 5 (use preset 1 and 5) until both frequencies are at maximum curve height.

NOTE: 105 MHz curveheight is typically slightly stronger than 90 MHz.

C IF ADJUSTMENT

- 1 Set tuner to approximately 98 MHz (the tuner must be tuned to an unoccupied frequency) enter into preset 3, and tune FM generator to display a curve on oscilloscope.
- 2 Adjust L 8 and L 101 to maximum and symmetrical curve on the display, using as little input as possible.

NOTE: Maximum input 500 μV , typical curveheight 4 mV at 150 μV and 15 mV at 300 μV .

D DETECTOR COARSE ADJUSTMENT (OPTIONAL, NEEDED ONLY IF DETECTOR WAS REPAIRED)

- 1 Reduce sweep modulation level to ± 75 kHz and set input level to $300 \mu\text{V}$.
- 2 Adjust FM generator frequency so that both legs of the inverted U-shaped curve are equally high on the display. The curve should be almost perfectly symmetrical.
- 3 Disconnect detectorprobe from tuner and oscilloscope. Connect either of the tape rec. outputs to the oscilloscope.
- 4 The oscilloscope should now display a diagonal line. Adjust L 102 primary (closest to IC 102) to maximum curveheight and L 102 secondary to minimum curve height and straightest possible line. Go back and forth between primary and secondary till both are peaked.

NOTE: Both the cores should be within 1.5mm from the top of the form.

E DETECTOR ALIGNMENT (FINAL)

- 1 Disconnect detectorprobe and connect tape rec. output to VTVM's, oscilloscope and distortion analyzer.
- 2 Switch stereo generator to 1 kHz 100% (± 75 kHz) mono modulation and oscilloscope to normal internal sweep 0.2 mS and 0.5 V/cm sensitivity.
- 3 Detector reference frequency.

Reduce FM generator output level while monitoring THD from left channel. When THD increases to 3%, fine tune the FM generator frequency to minimum THD. Reduce FM generator output level and fine tune till no reduction in the 3% THD can be achieved by fine tuning. Use this frequency for all the following detector, MPX and DYN SEP adjustments.

NOTE: The typical input level for this 3% THD should be $1.6 \mu\text{V}$ to $2.3 \mu\text{V}$. This is done only to "line up" the frequency from the generator to the tuner's frequency.

If IHF usable sensitivity (-30 dB THD + N = 3.16%) is to be verified, a proper IHF bandpass-filter must be used.

- 4 Connect DMM across TP 104 (negative) and TP 105 (positive). Set FM generator output to $1000 \mu\text{V}$
- 5 Adjust L 102 primary (closest to IC 102) for 0 V on DMM.
TOLERANCE ± 50 mV
- 6 Adjust L 102 secondary for lowest THD.
SPECIFICATION less than 0.1%
- 7 Repeat steps 3, 5 and 6 till no further improvements. Record the DMM's final reading for use later in the adjustments. (1 - 3)

F AUTOSEARCH LEVEL.

- 1 Connect DMM between ground and TP 107.
- 2 Increase FM generator output upwards from 0 and adjust R 107 "MUTE" so that DMM reading goes from 0 V to approximately 4.8 V at $10 \mu\text{V}$ input.

TOLERANCE $\pm 2 \mu\text{V}$

G STEREO DECODER, MPX FILTERS.

- 1 VCO
Connect a frequency counter and a 200 k ohm resistor in parallel between ground and TP 108.
- 2 Set FM generator to $1000 \mu\text{V}$ output and no modulation.
- 3 Adjust R 164 "MPX VCO" for a 19000 Hz reading on the counter.

TOLERANCE ± 100 Hz

- 4 Disconnect frequency counter and resistor and depress DYN SEP defeat switch (in).
- 5 Stereo switch threshold.

Modulate FM generator 1 kHz 100% left only plus 19 kHz pilot 8 - 10%.

6 Increase FM generator level upwards from 0 and adjust R 167 "ST SW" so that stereo light turns on and audio outputs, as watched on VTVM's and oscilloscope, switches to one channel only at 10 μ V input level.

TOLERANCE + 5 μ V

NOTE: When turning input level down the unit will switch into mono at a lower level, typically 7 μ V.

7 Stereo separation.

Set FM generator output to 1000 μ V, modulate left channel only.

8 Adjust R 158 for minimum on right channel VTVM.

9 Modulate FM generator right channel only and adjust R 158 for minimum on left channel VTVM.

10 If the minimum in step 8 and 9 are different, adjust R 158 so that the readings are the same in both channels.

SPECIFICATION better than 50 dB separation

11 MPX filter

Turn off audiomodulation, leaving pilot tone only. Disable IHF filter, or external 19 KHz filter.

12 Check 19/38 KHz suppression.

SPECIFICATION more than 60 dB

13 If unit does not meet specification adjust FL 102 "MPX FILTER" on left channel and FL 103 "MPX FILTER" on right channel to minimum output.

NOTE: DO NOT ADJUST THE MPX FILTERS UNLESS NECESSARY, the cores are brittle and break easily.

14 Release the DYN SEP DEFEAT switch (out).

H DYN SEP ADJUSTMENTS.

1 Turn R 256 "DYN SEP OFF", R 249 and 250 "DYN SEP" fully clockwise.

2 DYN SEP separation effect.

Observe output from left channel with FM generator output level 1000 μ V and modulated 1 KHz left channel only.
Reduce audiomodulation only from stereo generator so that left channel output is reduced by 6 dB (50% stereo modulation).

3 The 19 KHz pilot signal MUST REMAIN modulated 8 - 10%.

Set FM generator output to 50 μ V and adjust R 249 "DYN SEP" for -30 dB separation left to right channel.

TOLERANCE \pm 2 dB

4 Switch modulation to right channel only while maintaining the same modulation levels.

Adjust R 250 "DYN SEP" for -30 dB separation right to left channel.

TOLERANCE \pm 2 dB

5 DYN SEP auto defeat level.

Set generator output to 200 μ V and adjust R 256 "DYN SEP OFF" so that separation starts increasing when watching left channel VTVM. Adjust FM generator output up and down around 200 μ V and make sure switching occurs around 200 μ V.

TOLERANCE + 100 μ V - 30 μ V

I SYNTHESIZER FREQUENCY

1 Tune to a known accurate frequency source, i.e., broadcasting station or synthesized/digital display FM generator preferably in the midband 95 - 100 MHz.

2 Connect DMM across TP 104 (negative) and TP 105 (positive).

3 Adjust C 209 "FO" so that DMM reads the same as recorded in E - 7.

TOLERANCE \pm 10 mV

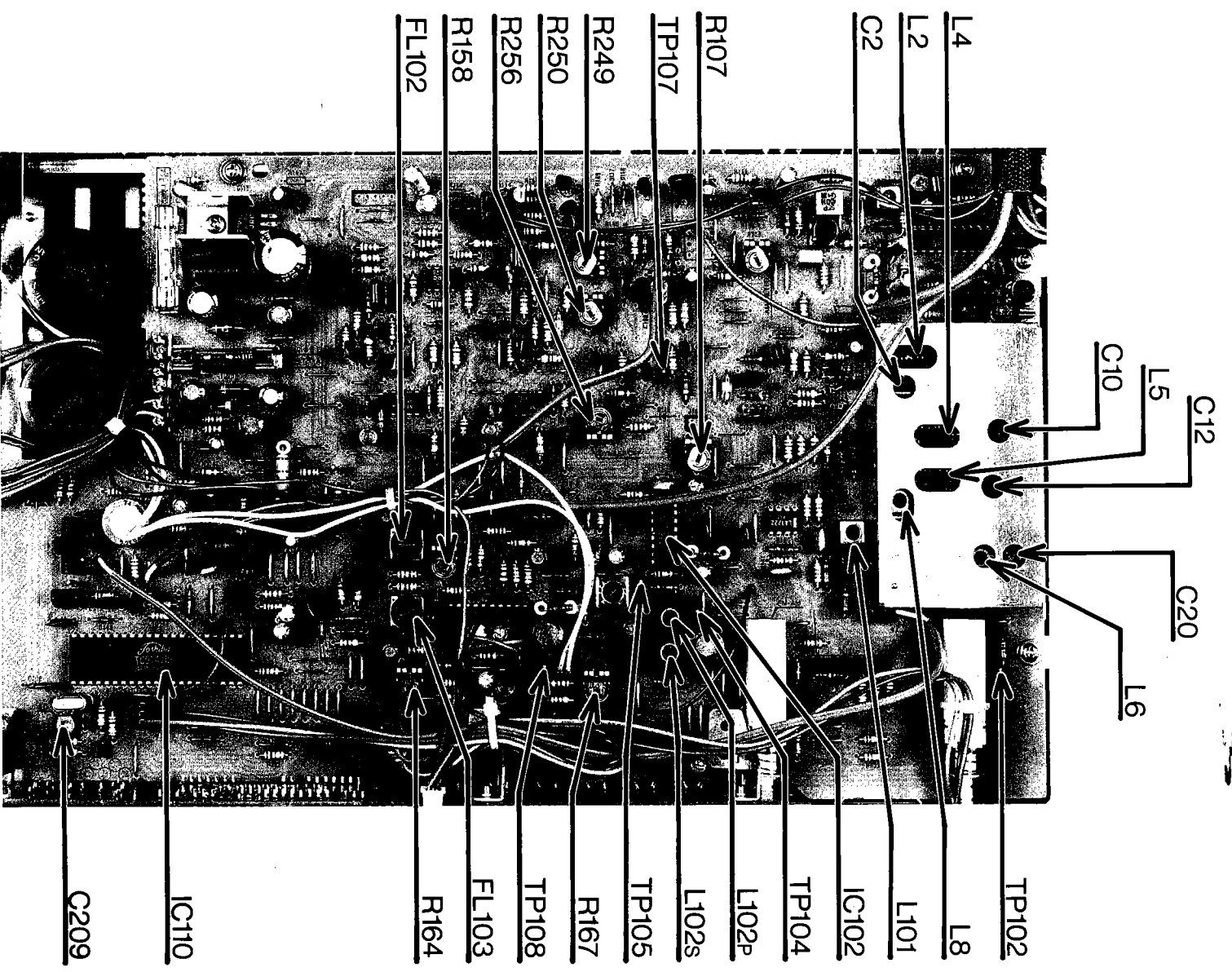

AM ALIGNMENTS

A OSCILLATOR.

- 1 Connect DMM to TP 101 and grd.
- 2 Tune to 1710 KHz. Enter into preset 1. Adjust C 148 for reading of 31 ± 0.5 VDC.
- 3 Tune to 520 KHz. Enter into preset 2. Adjust L 103 for reading of 1.8 ± 0.1 VDC.
- 4 Repeat steps 2 and 3 until within tolerances.

B ANTENNA, IF

- 1 Swing antenna away from chassis and peel back label (if present) to expose adjustment tab.
- 2 Connect DC voltmeter to center tap, R 208 and grd.
- 3 Tune to station of moderate strength, near 600 KHz. Enter into preset 3. Adjust L 951 (move tab under label on antenna) for maximum reading on meter. (Use non-interactive tool, such as plastic or wooden stick.)
- 4 Adjust L 104 and L 106 for maximum reading on meter.
- 5 Tune station of moderate strength near 1400 KHz. Enter into preset 4. Adjust C 147 for maximum reading on meter.
- 6 Repeat steps 3 and 5 until no further improvement is seen.

C SIGNAL METER, AUTO STOP

R 208 controls signal strength indication and auto stop level, adjust only if necessary, to correct for scan stopping on excessively weak signals, or failure to stop on moderately strong ones.

NOTE: When finished, lock antenna bar adjustment with laquer (nail polish), re-install label.

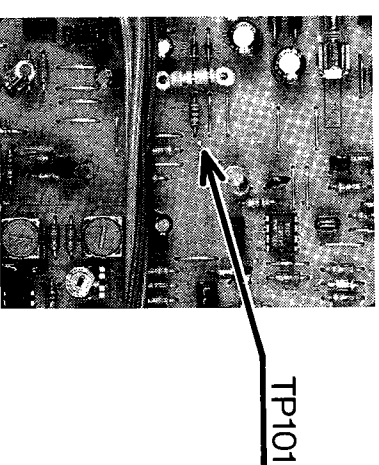
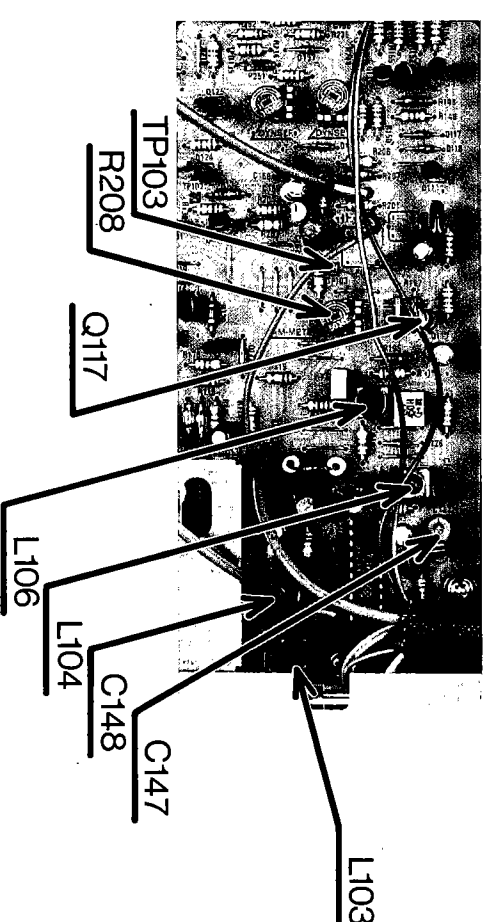
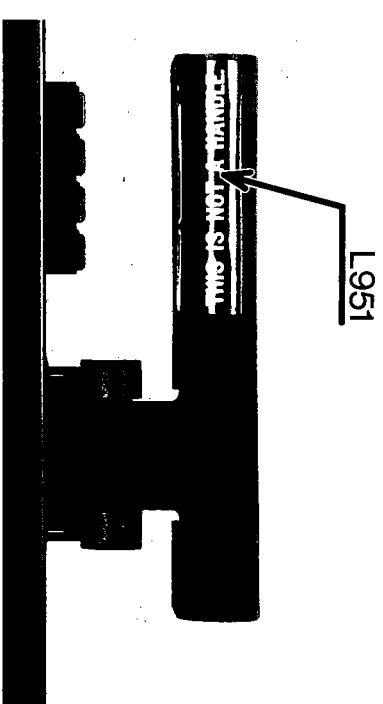

AMPLIFIER ALIGNMENTS

A IDLE (QUIESCENT) CURRENT

- 1 Connect mV meter (DVM) from TP 701 to TP 702, left chan. (from TP 751 to TP 752, right chan.)
- 2 Adjust R 721, left chan. (R 771, right chan.) so that meter reading is 20 - 25 mVDC.

NOTE: Reading may take a few minutes to stabilize; re-check after offset adjustment (next step.)

B OFFSET (CENTERING) VOLTAGE:

Adjust R 708, left (R 758, right) so that voltage at spkr. terminals is 0 ± 50 mVDC.

NOTE: Perform these adjustments with no load, volume minimum.

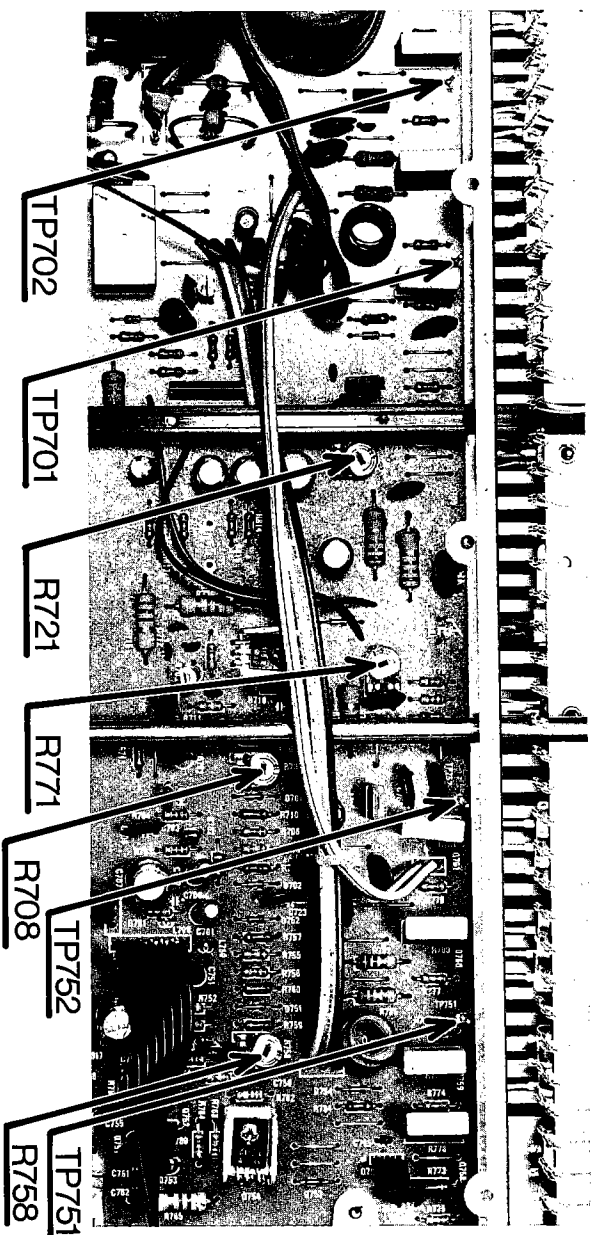

AMPLIFIER P.C.B. LAYOUT DIAGRAM

SPEAKER TERMINAL PCB

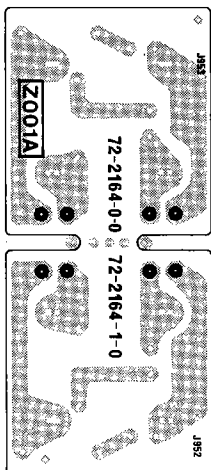

LED DISPLAY PCB



SPEAKER SWITCH PCB

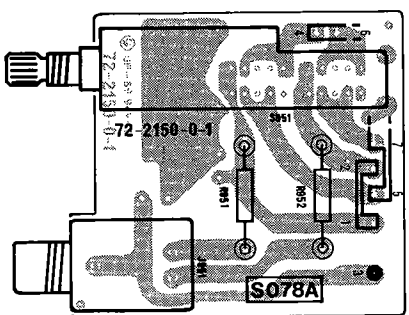

POWER SWITCH PCB

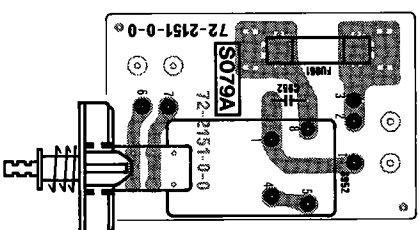

INPUT/OUTPUT PCB

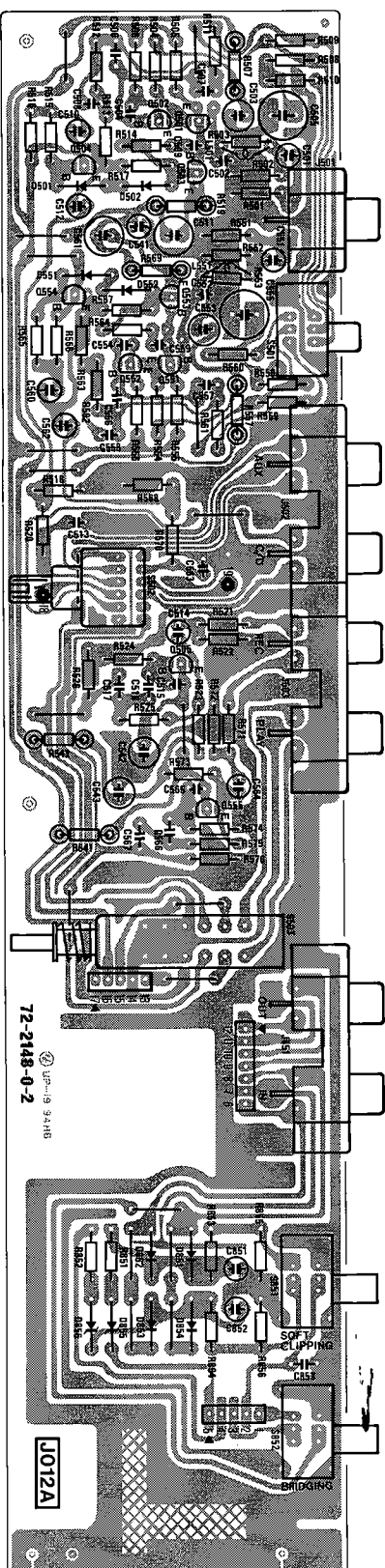

MAIN/CONTROL AMP. & POWER SUPPLY PCB

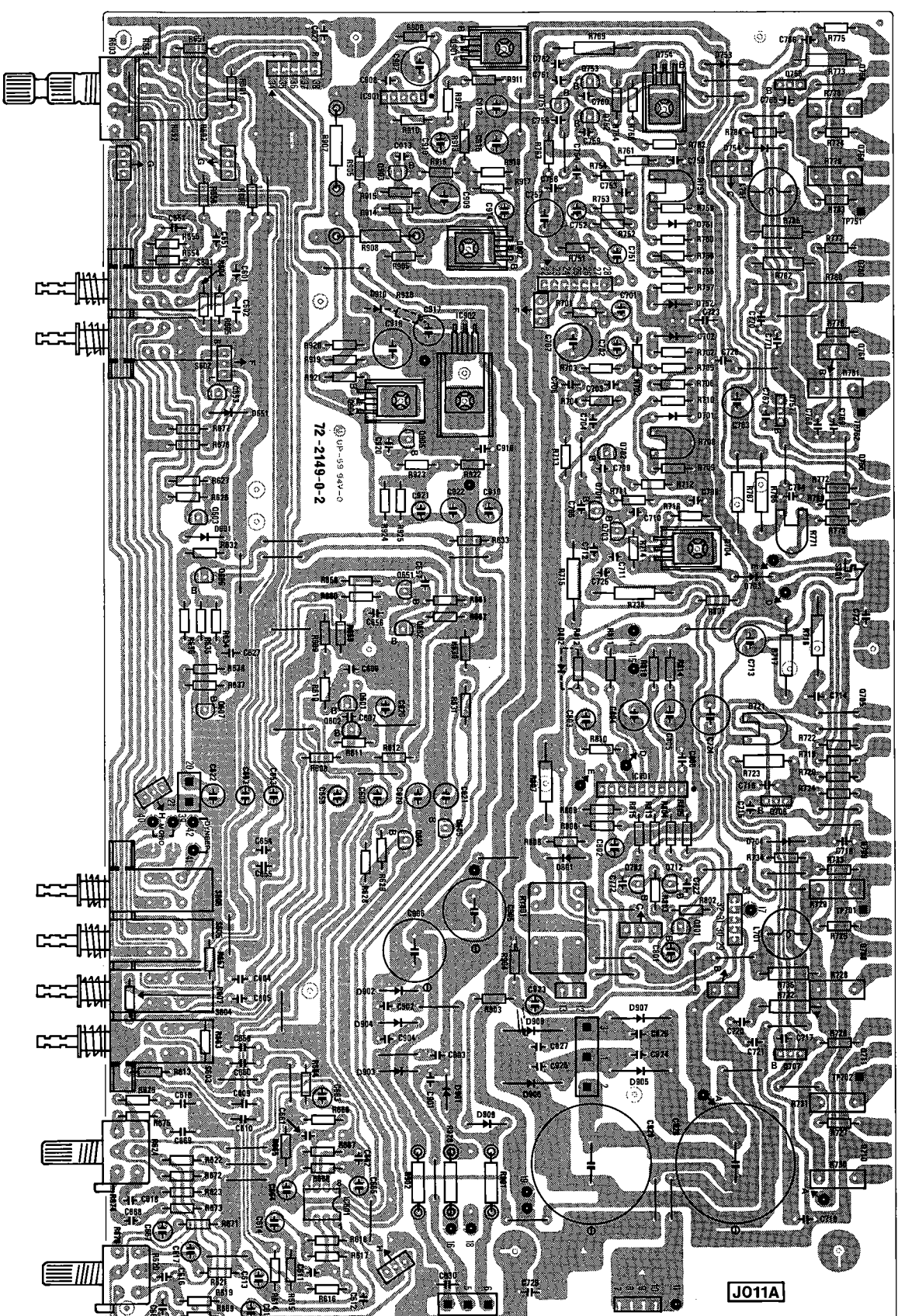

SCHEMATIC DIAGRAM NAD 7140 AMPLIFIER SECTION

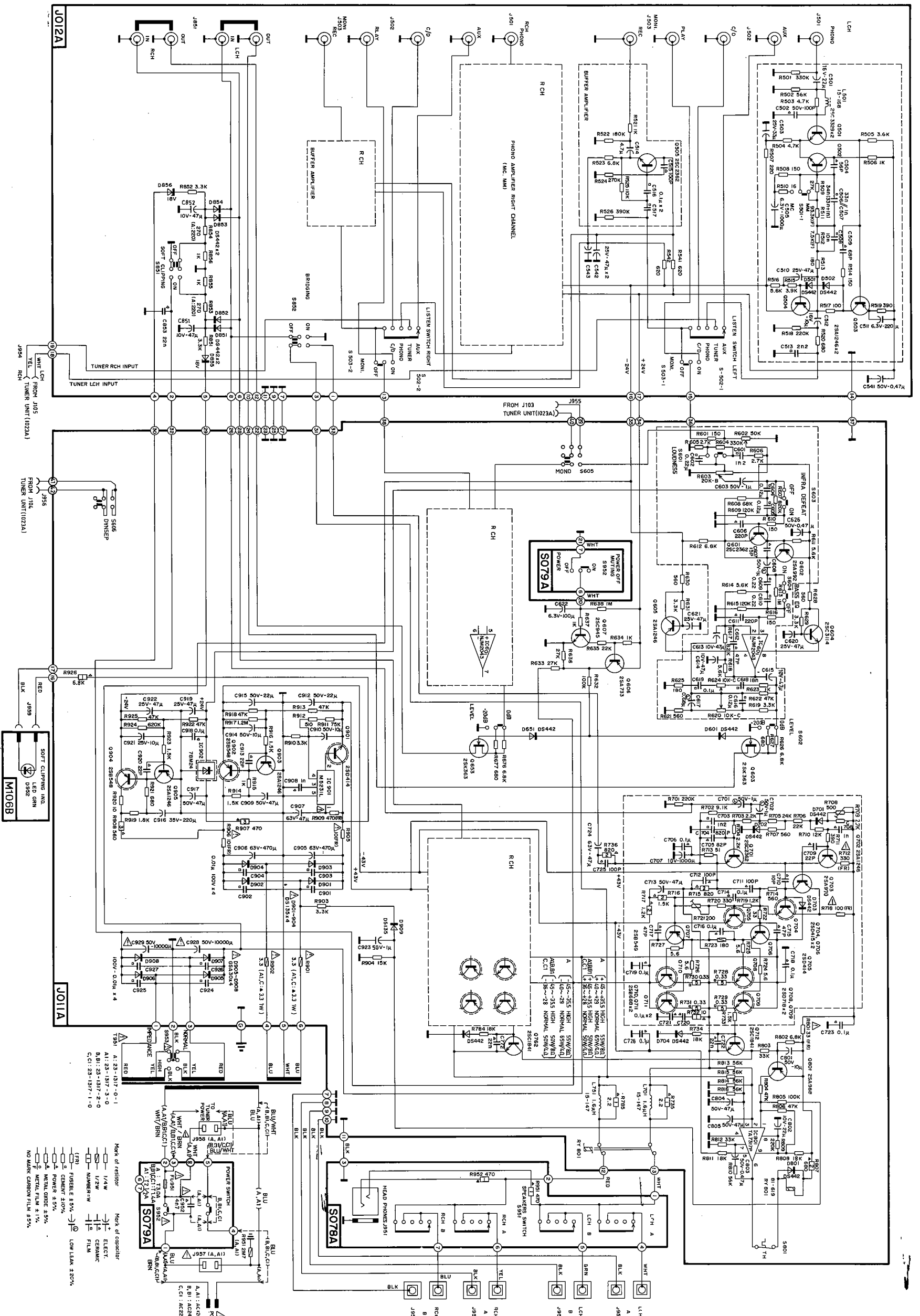

TUNER P.C.B. LAYOUT DIAGRAM

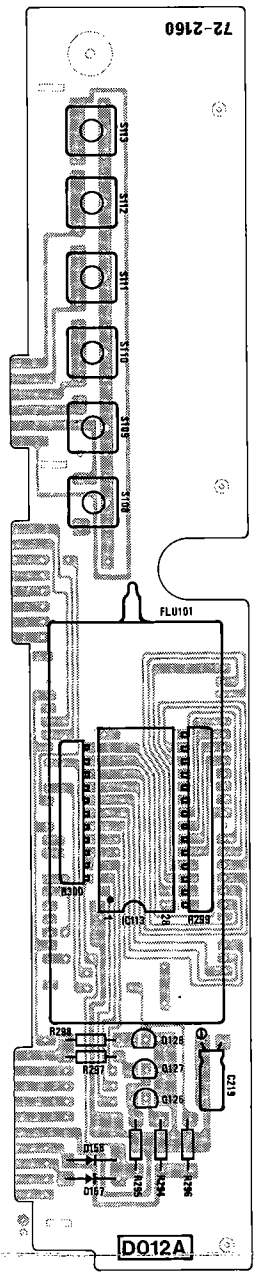

DISPLAY & PRESET SELECTOR PCB

ANTENNA TERMINAL PCB

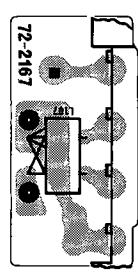

TUNER PCB

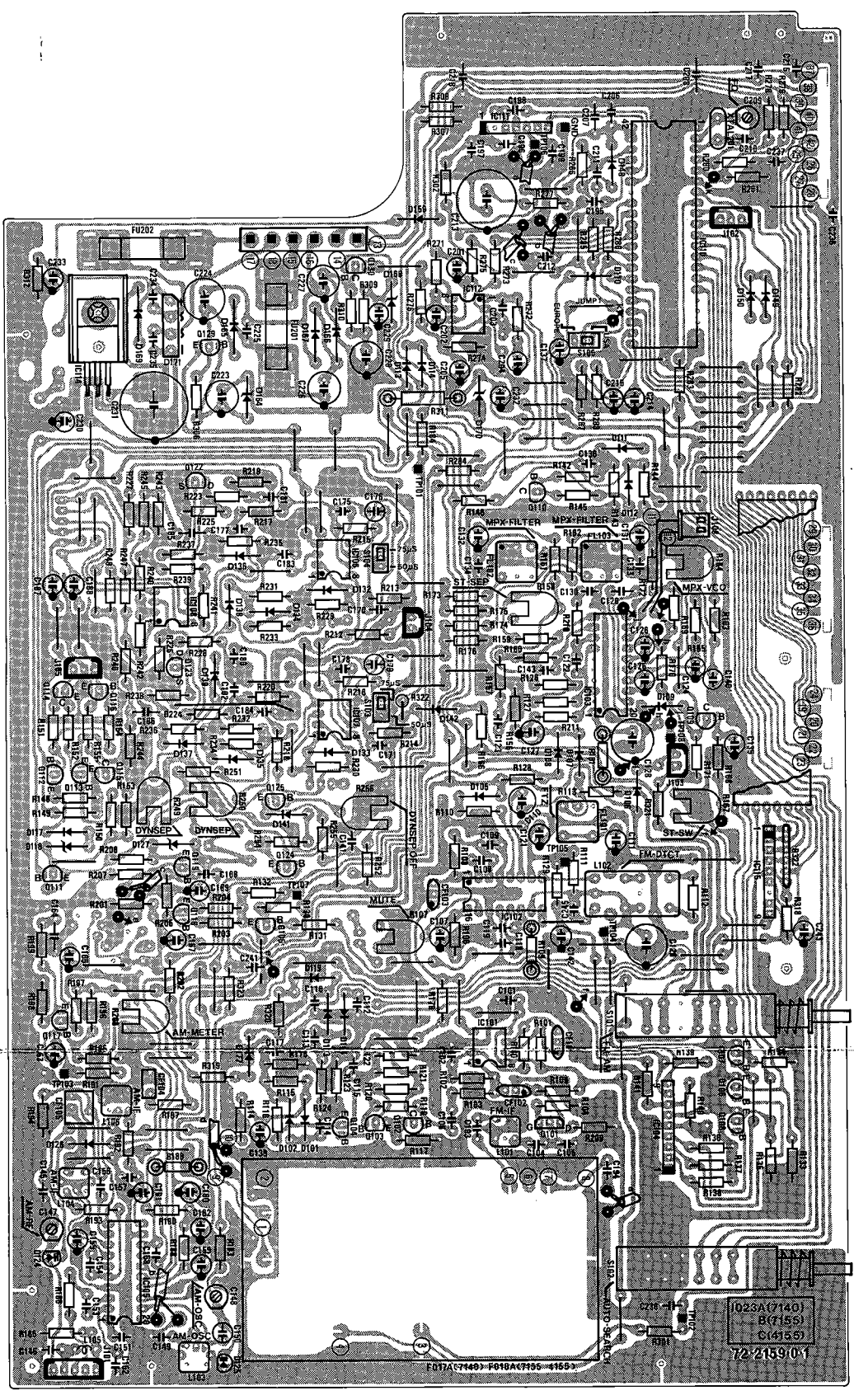

FRONTEND PCB

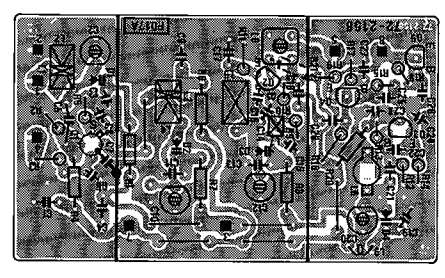

UP/DOWN PCB

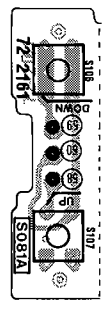

WIRING DIAGRAM

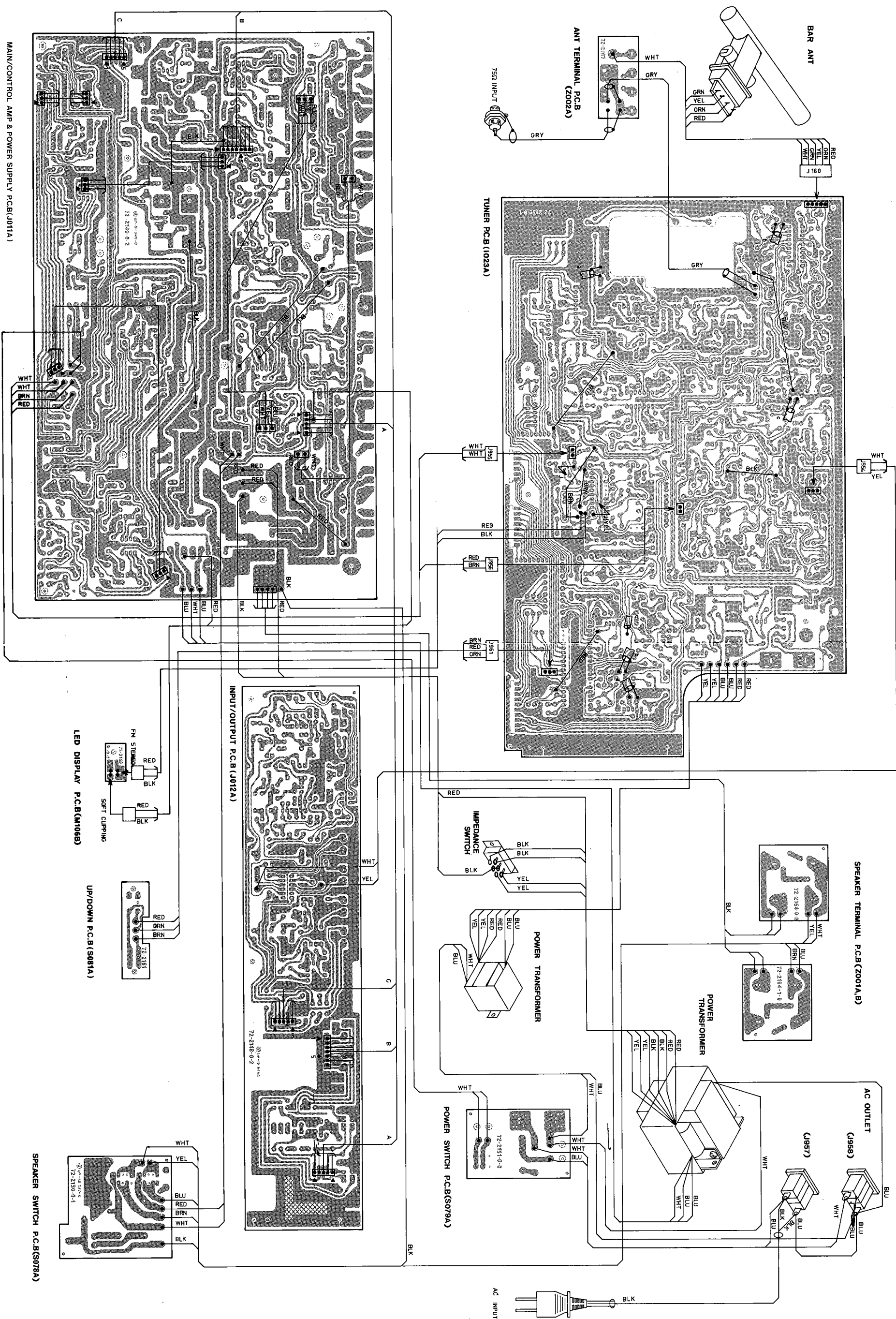

MAIN/CONTROL AMP & POWER SUPPLY P.C.B.(J011A)

TUNER P.C.B.(J023A)

INPUT/OUTPUT P.C.B.(J012A)

ANT TERMINAL P.C.B.(Z002A)

SPEAKER TERMINAL P.C.B.(Z001A,B)

LED DISPLAY P.C.B.(M106B)

UP/DOWN P.C.B.(S081A)

SPEAKER SWITCH P.C.B.(S078A)

EXPLODED VIEW PARTS LIST

Ref. No.	Parts No.	Descriptions
1	63-6273-0-0	FRONT PANEL
2	62-1105-0-0	PUSH BUTTON - SELECTORS
3	62-1105-1-0	PUSH BUTTON - ON/OFF
4	62-3465-0-0	PUSH BUTTON FRAME - SINGLE HOLE
5	62-3466-0-0	PUSH BUTTON FRAME - TWO HOLES
6	62-3468-0-0	PUSH BUTTON FRAME - FOUR HOLES
7	62-2317-0-0	ROTARY KNOB - TONE CONTROL/SELECTORS
8	62-2318-0-0	ROTARY KNOB - BALANCE
9	62-2319-0-0	ROTARY KNOB - VOLUME
10	62-3469-0-0	DISPLAY PANEL
11	62-1106-0-0	PUSH BUTTON - BLACK
12	62-1106-1-0	PUSH BUTTON - LIGHT BROWN
13	62-3471-0-0	PUSH BUTTON PLUNGER
14	62-1107-0-0	ROCKER BUTTON - UP/DOWN SEARCH
15	62-1108-0-0	PUSH BUTTON - AUTO SEARCH
16	88- 170-0-0	SPRING - PUSH BUTTON RETURN
17	63-5169-0-0	DISPLAY WINDOW
18	92-2102-0-0	FOOT - SNAP ON TYPE
	92-2103-0-0	FOOT - PLASTIC RIVET TYPE
19	63-1844-0-0	LABEL : THIS IS NOT A HANDLE.
20	63-1845-0-0	PLATE (POLYESTER)
26	71-2584-0-0	FRONT SUBCHASSIS
27	92-1175-0-0	INSULATOR (PVC) (B B1 C C1)
28	71-2586-0-0	SIDE CHASSIS (L)
29	71-2587-0-0	SIDE CHASSIS (R)
30	71-2588-0-0	SUBCHASSIS (FRONT TO REAR SUPPORT)
31	71-2589-0-0	SUBCHASSIS (LEFT TO RIGHT SUPPORT)
32	71-1891-0-0	THERMAL SWITCH CLAMP
33	92-1225-0-0	INSULATOR (PVC) (A A1 AC RECEPTACLE)
34	92-1223-0-1	LOCKING PLATE - IMPEDANCE SWITCH
35	92-1224-0-0	LOCKING PLATE - BRIDGING SWITCH
36	71-2585-0-0	REAR PANEL (A A1)
	71-2600-0-0	REAR PANEL (C C1)
	71-2600-1-0	REAR PANEL (B B1)
37	71-3107-0-0	CABINET
38	71-3104-0-0	BOTTOM COVER
44	23-1317-0-1	POWER TRANSFORMER (A)
	23-1317-1-0	POWER TRANSFORMER (C C1)
	23-1317-2-0	POWER TRANSFORMER (B B1)
	23-1317-3-0	POWER TRANSFORMER (A1)
45	23-1320-0-0	TUNER POWER TRANSFORMER (A)
	23-1320-1-0	TUNER POWER TRANSFORMER (C C1)
	23-1320-2-0	TUNER POWER TRANSFORMER (B B1)
	23-1320-3-0	TUNER POWER TRANSFORMER (A1)
46	85- 258-0-0	POWER CORD (A)
	85- 235-0-0	POWER CORD (C C1)
	85- 240-0-0	POWER CORD (B)
	85- 259-0-0	POWER CORD (B1)
	85- 260-0-0	POWER CORD (A1)
47	82-2161-0-0	RECEPTACLE (A A1)

Ref. No.	Parts No.	Descriptions
48	82-2162-0-0	F TYPE ANTENNA CONNECTOR (A A1)
	82- 293-0-0	DIN TYPE ANTENNA CONNECTOR (B B1 C C1)
50	81- 450-0-0	SLIDE SWITCH - IMPEDANCE SELECTOR (A B B1 C C1)
	81- 452-0-0	SLIDE SWITCH - IMPEDANCE SELECTOR (A1)
51	74-3103-0-0	HEAT SINK
52	82- 118-0-0	JUMPER CONNECTOR
53	65- 128-0-0	SHAFT - SELECTOR
54	62-3472-0-0	BUSHING FOR SHAFT SELECTOR
55	62-3474-0-0	JOINT FOR SHAFT SELECTOR
56	62-3473-0-0	EXTENTION SHAFT TAPE MONITOR
57	87-3242-0-0	GROUND TERMINAL
58	87-3243-0-0	STUD BOTTOM COVER SUPPORT
59	11-5120-0-0	AM BAR ANTENNA
60	62-3332-0-0	BUSHING - AC POWER CORD
61	63-1843-0-0	LABEL (CAUTION FOR FUSE) (A A1)
66	J012A	INPUT/OUTPUT PCB
66 - 1	82-2130-0-0	RCA CONNECTORS - SINGLE
66 - 2	82-2157-0-0	RCA CONNECTORS - DOUBLE
66 - 3	81- 447-0-0	SLIDE SWITCH - SOFT CLIPPING & BRIDGING & MM/MC
66 - 4	81- 182-0-0	ROTARY SWITCH - LISTEN SELECTOR
66 - 5	81-2325-0-0	PUSH SWITCH - TAPE MONITOR
67	J011A	MAIN/CONTROL AMP & POWER SUPPLY PCB
67 - 1	41- 685-0-0	ROTARY POTENTIOMETER - BASS & TREBLE
67 - 2	41- 686-0-0	ROTARY POTENTIOMETER - VOLUME
67 - 3	81-2321-0-0	FUNCTION SWITCH BANK (4 SWITCHES)
67 - 4	81-2323-0-0	FUNCTION SWITCH BANK (2 SWITCHES)
68	S078A	SPEAKER SWITCH PCB
68 - 1	82-2158-0-0	HEADPHONE JACK
68 - 2	81- 183-0-0	ROTARY SWITCH - LOUDSPEAKER SELECTOR
69	S079A	POWER SWITCH PCB
69 - 1	81-2227-0-0	POWER SWITCH (A A1)
	81-2245-0-0	POWER SWITCH (B B1 C C1)
69 - 2	71-1894-0-0	FUSE HOLDER (A A1)
	71-1246-0-0	FUSE HOLDER (B B1 C C1)
69 - 3		FUSE (A) - MSL-3 250V
		FUSE (A1) - MSL-2-1/2 250V
		FUSE (B B1 C C1) - T1.4A 250V
70	Z001A/Z001B	SPEAKER TERMINAL PCB
70 - 1	82-2164-0-0	BINDINGPOST - LOUDSPEAKERS
71	M106B	LED DISPLAY PCB
72	F017A	FM FRONTEND PCB
73	I023A	TUNER PCB
73 - 1	71-1889-0-0	PCB SUPPORT
73 - 2	74- 388-0-0	HEAT SINK
73 - 3	81-2325-0-0	FM/AM SELECTOR SWITCH & AUTO SEARCH SWITCH
74	D012A	DISPLAY & PRESET SELECTOR PCB
74 - 1	7AM8AS	FLUORESCENT INDICATOR TUBE
74 - 2	81-2326-0-0	MOMENTARY SWITCH - PRE-SET & UP/DOWN
75	S081A	UP/DOWN PCB
76	Z002A	ANTENNA TERMINAL PCB

EXPLODED VIEW

Ref. No.	Parts No.	Descriptions
76 - 1	82-2163-0-0	CONNECTORS - ANTENNA TERMINAL
80		TAPPING SCREW (PHILLIP'S HEAD 3 x 6 C ¹)
81		TAPPING SCREW (PHILLIP'S HEAD 3 x 8 C ¹)
82		TAPPING SCREW (PHILLIP'S HEAD 3 x 6 BLK)
83		TAPPING SCREW (PHILLIP'S HEAD 3 x 8 BLK)
84		TAPPING SCREW (WASHER HEAD 3 x 6 C ¹)
85		MACHINE SCREW S (WASHER HEAD 3 x 6 C ¹)
87		MACHINE SCREW S (PHILLIP'S HEAD 3 x 8 BLK)
88		MACHINE SCREW (PAN 3 x 6 C ¹)
89		MACHINE SCREW (PHILLIP'S HEAD 3 x 8 BLK)
90		MACHINE SCREW S (PHILLIP'S HEAD 4 x 6 C ¹)
91		RETAINING RING (E TYPE 5mm)
92		WASHER (PLAIN 4-10-0.8 NI)
93		WASHER (TOOTHED LOCK B 4 NI)
94		WASHER (TOOTHED LOCK B 3 NI) (A A1)
95		NUT (HEXAGON M4-7.3.2 C ¹)
96		TERMINAL LUG (A A1)
97		TAPPING SCREW (PAN 2.6 x 6 C ¹)
98		MACHINE SCREW (PHILLIP'S HEAD 3 x 6 C ¹)
99		CABINET SCREW WITH WASHER (4 x 6 BLK)
100		HEAD PHONE JACK NUT (HEXAGON 12-14-2)
101		WASHER (PLAIN 12-18-0.5)
102		SPEAKER SWITCH NUT (HEXAGON 7-10-2)
103		WASHER (PLAIN 7-12-0.5)
104		tone CONTROLS NUT (HEXAGON 7-11-2)
105		VOLUME CONTROL NUT (HEXAGON 9-11-2)
106		WASHER (PLAIN 9-14-0.5)
107		F-CONNECTOR NUT (HEXAGON UNF 3/8-11-2)
108		TERMINAL LUG (MET 31-0107)

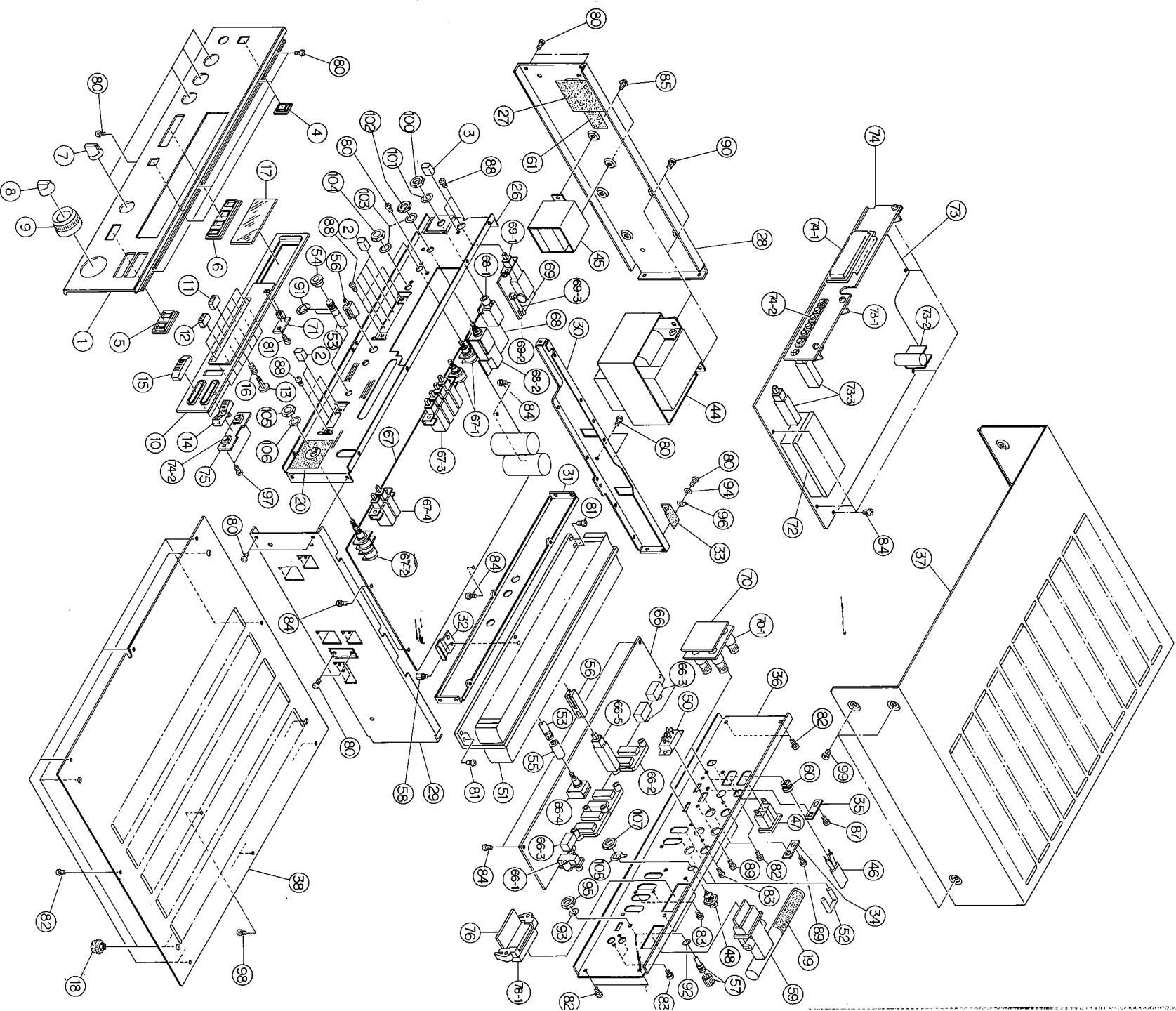

ELECTRICAL PARTS LIST

NOTE: This is not a complete electrical parts list.

FRONTEND P.C.B.: F017A (EXPLODED VIEW REF. NO.72)

SYMBOL NO.	PARTS NO.	DESCRIPTIONS
Q1	3SK45(B)	F.E.T.
Q4	2SC461(B)	TRANSISTOR
Q2, Q3, Q5	2SC535(B)	TRANSISTOR
D1 - D4	1SV53	DIODE, VARIABLE CAPACITANCE
L1	11-434	FM ANTENNA COIL, PRIMARY
L2, L4, L5	11-412	" , SECONDARY
L3	11-435	FM RF COIL
L6	12-565	OSC COIL
L7	15-152	CHOKE COIL
L8	13-533	IFT COIL
L9	15-166	CHOKE COIL
C2, C10, C12, C20	36-134	TRIMMER CAPACITOR, 3 - 11pF
C19	50V, 100pF, J, RH	CERAMIC CAPACITOR
C21	50V, 8pF, ±0.5pF, RH	"
C22	50V, 15pF, K, SH	"
C24	50V, 10pF, ±0.5pF, SH	"
C25	50V, 3pF, ±0.5pF, CJ	"
C28	50V, 2pF, ±0.25pF, CK	"

TUNER P.C.B.: I023A (EXPLODED VIEW REF. NO.73)

SYMBOL NO.	PARTS NO.	DESCRIPTIONS
IC101	LA1222	INTEGRATED CIRCUIT
IC102	LA1235	"
IC103	LA3390	"
IC104	LB1450	"
IC105	LA1245	"
IC106, IC107, IC122	uPC4558	"
IC108	NJM072D	"
IC110	TC9147P	"
IC111	TD6104P	"
IC114	L78M12	"
IC115	BA656	"
Q101	2SK212(E)	F.E.T.
Q102 - Q104	2SC929(E)	TRANSISTOR
Q105, Q109, Q110	2SC1815(Y,GR)	"
Q113 - Q118, Q124	"	"
Q130	"	"
Q106 - Q108, Q111	2SA1015(Y, GR)	"
Q112, Q119, Q125	"	"
Q129	"	"
Q122, Q123	2SK30A(GR)	F.E.T.
D101 - D104, D119	1S446	DIODE
D134, D135	"	"
D105 - D114, D117, D126	DS442BT	"
D132, D133, D136 - D139	"	"
D141, D142, D148 - D150	"	"
D159, D177	"	"

SYMBOL NO.	PARTS NO.	DESCRIPTIONS
D118	GZA68Y	ZENER DIODE
D127	GZA39Y	"
D164	GZA13X	"
D168	GZA36X	"
D170	GZA5.6Y	"
D124, D125	FC66M	VARACTOR DIODE
D165 - D167, D169	SR-1K	RECTIFIER
D171	DBA10B	"

L101	13-538	IFT COIL
L102	13-536	FM DETECTOR COIL
L103	12-564	AM OSCILLATOR COIL
L104	13-348	450KHz MATCHING COIL
L105	15-167	CHOKE COIL, 120μH
L106	13-347	AM IFT COIL
FL101	19-138	ANTIBIRDY FILTER
FL102, FL103	19-151	LOW PASS FILTER
CF101 - CF103	19-154	CERAMIC FILTER
CF104	19-136	"
CF105	19-140	"
C104	50V, 68pF, J, RH	CERAMIC CAPACITOR
C105	50V, 100pF, J, RH	"
C121	50V, 0.68μF	ELECTROLYTIC CAPACITOR, LOW LEAKAGE
C124	50V, 3.3μF	"
C125, C160, C214	50V, 2.2μF	"
C126, C169, C215	50V, 1μF	"
C147, C148, C209	36-136	TRIMMER CAPACITOR, 5.2 - 30pF
C163, C204	50V, 0.22μF	ELECTROLYTIC CAPACITOR, LOW LEAKAGE
C201	50V, 0.33μF	"
C202, C243	50V, 0.1μF	"
C213	5.5V, 0.047μF	MEMORY BACKUP CAPACITOR
C245	50V, 68pF, J, COG]	CERAMIC CAPACITOR
R107, R167	20KΩ, B	VARIABLE RESISTOR
R158, R208	50KΩ, B	"
R164, R249, R250	10KΩ, B	"
R256	5KΩ, B	"
R311	240Ω, 1W	OXIDE METAL RESISTOR, RSFF1B
R322	220KΩ x 5	RESISTOR ARRAY
XTAL201	19-205	CRYSTAL, 7.2MHZ
S103, S104	81-451	DEEMPHASIS, SLIDE SWITCH
S105	"	9/10KHz.
FU201	MDL1/10	FUSE, 250V, 1/10A (A VERSION)
FU202	100mA	FUSE, 250V, 100mA (B, C VERSION)
	MDL3/8	FUSE, 250V, 3/8A (A VERSION)
	315mA	FUSE, 250V, 315mA (B, C VERSION)

DISPLAY & PRESET SELECTOR P.C.B.: D012A (EXPLODED VIEW REF. NO. 74)

SYMBOL NO.	PARTS NO.	DESCRIPTIONS
IC113	TD6301AP	INTEGRATED CIRCUIT
Q126 - 128	25C1815	TRANSISTOR
D157, D158	DS442	DIODE
R229	33K Ω x 13	RESISTOR ARRAY
R300	33K Ω x 10	"
FLU101	7AM8AS	FL INDICATOR

ANTENNA TERMINAL P.C.B.: Z002A (EXPLODED VIEW REF. NO. 76)

SYMBOL NO.	PARTS NO.	DESCRIPTIONS
L107	11-419	BALUN TRANSFORMER

INPUT/OUTPUT P.C.B.: J012A (EXPLODED VIEW REF. NO. 66)

SYMBOL NO.	PARTS NO.	DESCRIPTIONS
Q501, Q502	25C3329	TRANSISTOR
Q551, Q552	"	"
Q503, Q504	25A1246	"
Q553, Q554	"	"
Q505, Q555	25C2362	"
D501, D502, D551	DS442BT	DIODE
D552, D851 - D854	"	"
D855, D856	GZA18Y	ZENER DIODE
R511, R561	95.3K Ω , F, 1/4W	METAL FILM RESISTOR, SN14K2E
R512, R562	7.5K Ω , F, 1/4W	"
L501, L551	15-168	CHOKE COIL

MAIN/CONTROL AMP & POWER SUPPLY P.C.B.: J011A (EXPLODED VIEW REF. NO. 67)

SYMBOL NO.	PARTS NO.	DESCRIPTIONS
IC601	NJM2043D	INTEGRATED CIRCUIT
IC801	TA7317P	"
IC901	M5231L	"
IC902	L78M24	"
Q601, Q651	25C2362	TRANSISTOR
Q701, Q751	25C2362	"
Q602, Q652	25A992	"
Q603, Q653	25K363	"
Q604	25C3114	F.E.T.
Q605, Q702, Q752	25A1246	TRANSISTOR
Q903, Q905	25A1246	"

SYMBOL NO. PARTS NO. DESCRIPTIONS

Q606	25A733A	TRANSISTOR
Q607	25C945A	"
Q703, Q753	25A970	"
Q704, Q706, Q754	25D415	"
Q756	"	"
Q705, Q755	25D414	"
Q707, Q757	25B549	"
Q708, Q709	25D718	"
Q758, Q759	"	"
Q710, Q711	25B688	"
Q760, Q761	"	"
Q712, Q762	25C1841	"
O801	25A988	"
O901	25D414	"
O902, O904	25B548	"
D601, D651, D701	DS442BT	DIODE
D702, D703, D704	"	"
D751, D752, D753	"	"
D754, D801, D802	"	"
D901 - D904, D909	DS135E	"
D905 - D908	GSA30C	"
L701, L751	15-147	COIL
C603, C608, C653	50V, 1 μ F, HL	ELECTROLYTIC CAPACITOR, LOW LEAKAGE
C658, C701, C702	"	"
C751, C752	"	"
C617, C667	50V, 0.68 μ F, HL	"
C928, C929	50V, 10000 μ F	"
R708, R758	41-783, RVF8P	VARIABLE RESISTOR, 500 Ω
R712, R762	330 Ω , J, 1/4W	FUSIBLE RESISTOR
R715, R765, R736	820 Ω , J, 2W	POWER RESISTOR
R716, R766	1.5K Ω , J, 2W	"
R717, R767	1.2K Ω , J, 2W	"
R718, R768	100 Ω , J, 1/4W	FUSIBLE RESISTOR
R721, R771	41-781, RVF8P	VARIABLE RESISTOR, 200 Ω
R728, R729, R730	0.33 Ω , K, 5W	CEMENTED WIREWOUND RESISTOR
R731, R778, R779	"	"
R780, R781	10 Ω , J, 1W	POWER RESISTOR
R732, R782	2.2 Ω , J, 1W	"
R735, R785	33 Ω , J, 1/4W	FUSIBLE RESISTOR
R801	680 Ω , J, 2W	OXIDE METAL RESISTOR, RSF2B
R807	3.3 Ω , J, 1W	"
R901, R902	10 Ω , J, 1/4W	FUSIBLE RESISTOR
R905, R906	470 Ω , J, 3W	POWER RESISTOR
R907	560 Ω , J, 3W	"
R908	470 Ω , J, 1/4W	FUSIBLE RESISTOR
R909	6.8K Ω , J, 1W	POWER RESISTOR
R926	"	"
RY801	81-619	RELAY
S801	81-7002	THERMOSTAT

SPEAKER SWITCH P.C.B.: S078A (EXPLODED VIEW REF. NO. 68)

SYMBOL NO.	PARTS NO.	DESCRIPTIONS
R951, R952	470Q, 1W	OXIDE METAL RESISTOR, RSF1B

POWER SWITCH P.C.B.: S079A (EXPLODED VIEW REF. NO. 69)

SYMBOL NO.	PARTS NO.	DESCRIPTIONS
C952	DE7100FZ	CERAMIC CAPACITOR
FU951	MSL-3 MSL-2.1/2 T, 1.4A	FUSE, 250V, 3A (A VERSION) FUSE, 125V, 2.1/2A (A1 VERSION) FUSE, 250V, 1.4A (B, C VERSION)
FUSE HOLDER	71-1894	A, A1 VERSION
"	71-1246	EXCEPT A, A1 VERSION

LED DISPLAY P.C.B.: M106B (EXPLODED VIEW REF. NO. 71)

SYMBOL NO.	PARTS NO.	DESCRIPTIONS
D951	SY440D	L.E.D., FM STEREO
D952	SG240D	L.E.D., SOFT CLIP